

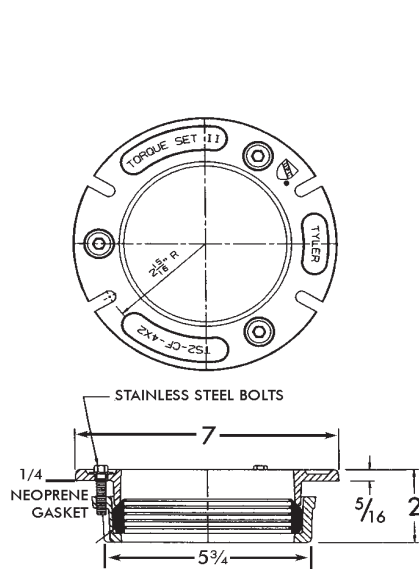

2-252 SERIES CLOSET FLANGES

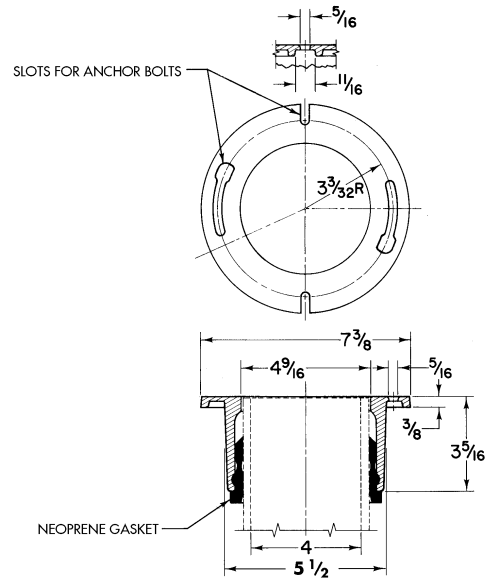

2-252TS
Torque Set Closet Flange
Fits 4" No-Hub or SV Pipe



2-252TY*
Push-On Closet Flange
U.S. Pat. No. 4,470,162

Ship Code	UPCode 670610	Item	Size	Wt.
S	022992	2-252TS	4x2 Torque Set	4.2
S	022954	2-252TY	4 Ty-Seal Hub*	5.8

*For minimum dimensions installed, see page 51

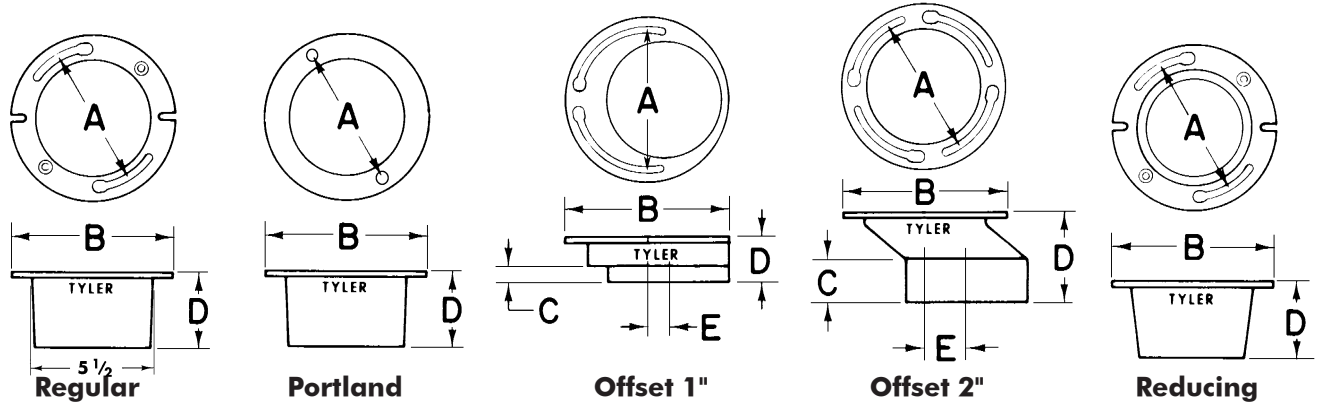

2-252 CLOSET FLANGE (Caulk Joint Application)

Ship Code	UPCode 670610	Size x Height	A	B	C	D	E	Wt.
S	022848	4x1	6 1/4	7 1/4	...	1	...	2.0
S	022855	4x1 1/2	6 1/4	7 1/4	...	1 1/2	...	2.0
S	022862	4x2	6 1/4	7 1/4	...	2	...	2.0
S	022923*	4x2	6 3/8	7 1/4	...	2	...	2.8
S	022879	4x2 1/2	6 1/4	7 1/4	...	2 1/2	...	3.0
S	022886	4x3	6 1/4	7 1/4	...	3	...	4.0
S	022893	4x4	6 1/4	7 1/4	...	4	...	5.0
S	022930*	4x4	6 3/8	7 1/4	...	4	...	5.0
S	022909	4x5	6 1/4	7 1/4	...	5	...	6.0
S	022916	4x6	6 1/4	7 1/4	...	6	...	6.0
S	022978	4x2, 1" Offset	6	7	5/8	2	1	2.5
S	022985	4x4, 2" Offset	6 1/4	7 1/4	2	4	2	4.5
S	022947	4x3-3" Reducing	6 1/4	7 1/4	...	3	...	3.0

*Portland Code, two 1/4" taps on top.