

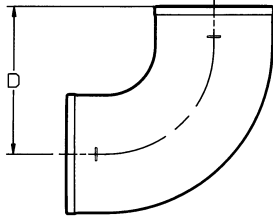

## NO-HUB ASA Group 022 BENDS & SWEEPS



**QUARTER BEND**

Ship Code	UPC No. 670610	Size	D	Wt.
S	006848	1 1/2	4 1/4	1.9
<b>S</b>	<b>006855</b>	<b>2</b>	<b>4 1/2</b>	<b>2.8</b>
S	006862	3	5	4.9
<b>S</b>	<b>006879</b>	<b>4</b>	<b>5 1/2</b>	<b>7.7</b>
S	006886	5	6 1/2	9.7
<b>S</b>	<b>006893</b>	<b>6</b>	<b>7</b>	<b>13.0</b>
S	006909	8	8 1/2	26.2

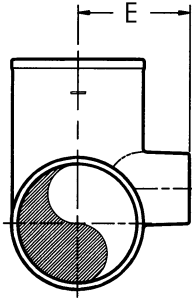

**QUARTER BEND  
w/ 2" Side Opening**

Ship Code	UPC No. 670610	Size	D	D'	E	Wt.
S	006923	3	5	4	3 1/4	4.4
<b>S</b>	<b>006930</b>	<b>4</b>	<b>5 1/2</b>	<b>4 5/16</b>	<b>3 3/4</b>	<b>7.5</b>

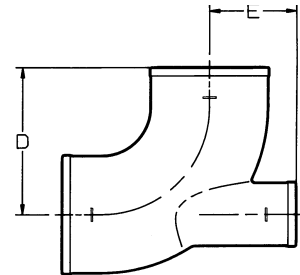
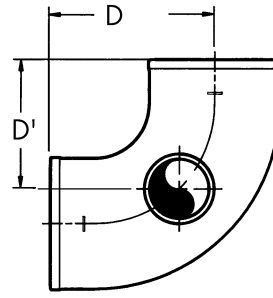

**QUARTER BEND  
w/ 2" Heel Opening**

Ship Code	UPC No. 670610	Size	D	E	Wt.
S	006947	3	5	2 7/8	4.4
<b>S</b>	<b>006954</b>	<b>4</b>	<b>5 1/2</b>	<b>3 1/4</b>	<b>6.5</b>

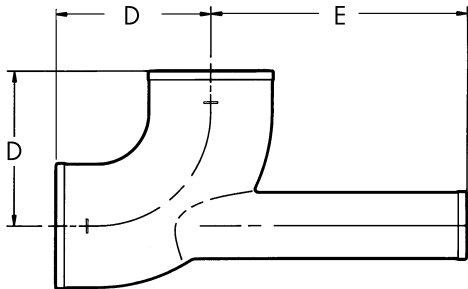

**QUARTER BEND  
EXTENDED HEEL OPENING**

Ship Code	UPC No. 670610	Size	D	E	Wt.
S	011019	3x2	5	10 1/2	7.8

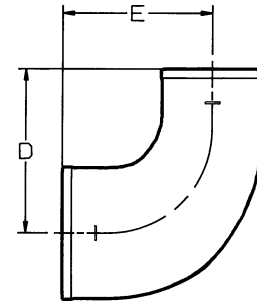

**REDUCING QUARTER BEND  
(FLA. STYLE)**

Ship Code	UPC No. 670610	Size	D	E	Wt.
S	006916	4x3	5 1/2	5	5.0

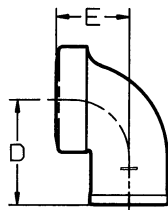

**TAP SHORT QUARTER BEND**

Ship Code	UPC No. 670610	Size	D	E	Wt.
S	006961	1 1/2 x 1 1/2	3	2	1.5
<b>S</b>	<b>006978</b>	<b>2 x 1 1/4</b>	<b>3 1/4</b>	<b>2 1/4</b>	<b>1.5</b>
S	006985	2 x 1 1/2	3 1/4	2 1/4	1.5
<b>S</b>	<b>006992</b>	<b>2 x 2</b>	<b>3 1/4</b>	<b>2 1/4</b>	<b>2.6</b>

### SHIPPING CODE

**S** = From Stock  
**N** = Non-Stock; Check in advance for availability.

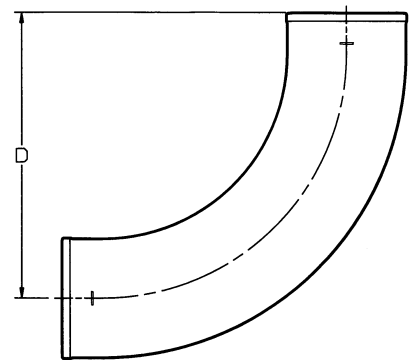

**LONG SWEEP**

Ship Code	UPC No. 670610	Size	D	Wt.
S	007180	1 1/2	9 1/4	4.1
<b>S</b>	<b>007197</b>	<b>2</b>	<b>9 1/2</b>	<b>6.0</b>
S	007203	3	10	8.5
<b>N</b>	<b>007258</b>	<b>4x3</b>	<b>10 1/2</b>	<b>11.5</b>
S	007210	4	10 1/2	13.4
<b>S</b>	<b>007227</b>	<b>5</b>	<b>11 1/2</b>	<b>17.0</b>
S	007234	6	12	20.9



# NO-HUB ASA Group 022 BENDS

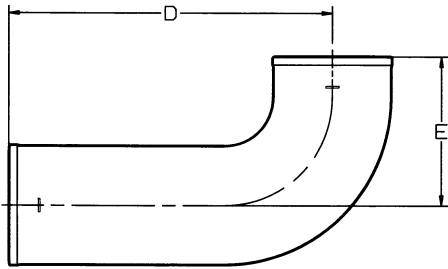

**LONG QUARTER BEND**

Ship Code	UPC No. 670610	Size-Lgth	D	E	Wt.
S	007067	2-12	12	4 <sup>1</sup> / <sub>2</sub>	5.0
<b>S</b>	<b>007043</b>	<b>2-14</b>	<b>14</b>	<b>4<sup>1</sup>/<sub>2</sub></b>	<b>5.6</b>
S	007050	2-16	16	4 <sup>1</sup> / <sub>2</sub>	6.3
<b>S</b>	<b>007074</b>	<b>2-18</b>	<b>18</b>	<b>4<sup>1</sup>/<sub>2</sub></b>	<b>6.7</b>
S	007081	3-12	12	5	7.3
<b>S</b>	<b>007098</b>	<b>3-18</b>	<b>18</b>	<b>5</b>	<b>10.4</b>
S	007104	4-12	12	5 <sup>1</sup> / <sub>2</sub>	10.2

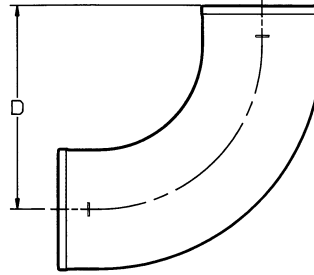

**SHORT SWEEP**

Ship Code	UPC No. 670610	Size	D	Wt.
S	007111	2	6 <sup>1</sup> / <sub>2</sub>	4.2
<b>S</b>	<b>007128</b>	<b>3</b>	<b>7</b>	<b>6.2</b>
S	007135	4	7 <sup>1</sup> / <sub>2</sub>	9.6
<b>S</b>	<b>007142</b>	<b>5</b>	<b>8<sup>1</sup>/<sub>2</sub></b>	<b>12.8</b>
S	007159	6	9	15.9
<b>S</b>	<b>007166</b>	<b>8</b>	<b>10<sup>1</sup>/<sub>2</sub></b>	<b>30.0</b>
S	007173	10	12	55.4
<b>S</b>	<b>376651</b>	<b>12</b>	<b>13<sup>1</sup>/<sub>4</sub></b>	<b>70.0</b>
S	376668	15	14 <sup>3</sup> / <sub>4</sub>	130.0

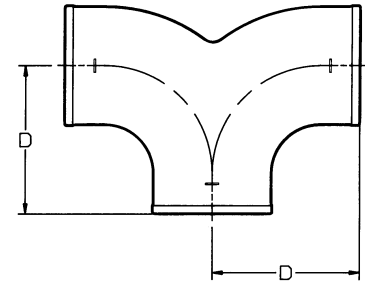

**DOUBLE QUARTER BEND**

Ship Code	UPC No. 670610	Size	D	Wt.
S	007012	2	4 <sup>1</sup> / <sub>2</sub>	3.6
<b>S</b>	<b>007029</b>	<b>3</b>	<b>5</b>	<b>6.0</b>
S	007036	4	5 <sup>1</sup> / <sub>2</sub>	9.8

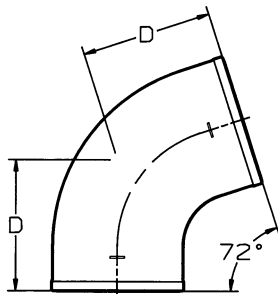

**FIFTH BEND**

Ship Code	UPC No. 670610	Size	D	Wt.
S	007265	2	3 <sup>11</sup> / <sub>16</sub>	2.0
<b>S</b>	<b>007272</b>	<b>3</b>	<b>4<sup>1</sup>/<sub>16</sub></b>	<b>3.5</b>
S	007289	4	4 <sup>7</sup> / <sub>16</sub>	5.5

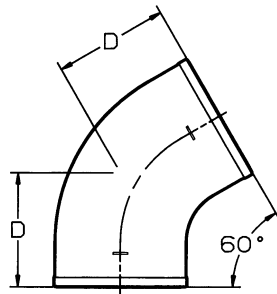

**SIXTH BEND**

Ship Code	UPC No. 670610	Size	D	Wt.
S	007296	2	3 <sup>1</sup> / <sub>2</sub>	2.0
<b>S</b>	<b>007302</b>	<b>3</b>	<b>3<sup>1</sup>/<sub>2</sub></b>	<b>3.0</b>
S	007319	4	3 <sup>3</sup> / <sub>16</sub>	5.1

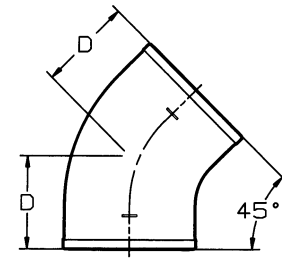

**EIGHTH BEND**

Ship Code	UPC No. 670610	Size	D	Wt.
S	007326	1 <sup>1</sup> / <sub>2</sub>	2 <sup>5</sup> / <sub>8</sub>	1.1
<b>S</b>	<b>007333</b>	<b>2</b>	<b>2<sup>3</sup>/<sub>4</sub></b>	<b>2.1</b>
S	007340	3	3	3.3
<b>S</b>	<b>007357</b>	<b>4</b>	<b>3<sup>1</sup>/<sub>8</sub></b>	<b>4.4</b>
S	007364	5	3 <sup>7</sup> / <sub>8</sub>	6.8
<b>S</b>	<b>007371</b>	<b>6</b>	<b>4<sup>1</sup>/<sub>16</sub></b>	<b>8.5</b>
S	007388	8	5	15.0
<b>S</b>	<b>007395</b>	<b>10</b>	<b>5<sup>15</sup>/<sub>16</sub></b>	<b>30.7</b>
S	376491	12	6 <sup>9</sup> / <sub>16</sub>	39.0
<b>S</b>	<b>376675</b>	<b>15</b>	<b>7<sup>3</sup>/<sub>16</sub></b>	<b>70.0</b>

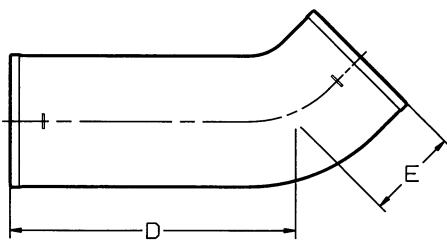

**LONG EIGHTH BEND**

Ship Code	UPC No. 670610	Size - Length	D	E	Wt.
N	382652	2-6	6	3	2.4
<b>S</b>	<b>007401</b>	<b>2-12</b>	<b>12</b>	<b>2<sup>3</sup>/<sub>4</sub></b>	<b>4.9</b>
S	007432	2-16	16	2 <sup>3</sup> / <sub>4</sub>	5.9
<b>S</b>	<b>007456</b>	<b>2-18</b>	<b>18</b>	<b>2<sup>3</sup>/<sub>4</sub></b>	<b>6.5</b>
S	007425	3-12	12	3	6.9
<b>S</b>	<b>007449</b>	<b>4-12</b>	<b>12</b>	<b>3<sup>1</sup>/<sub>8</sub></b>	<b>10.4</b>

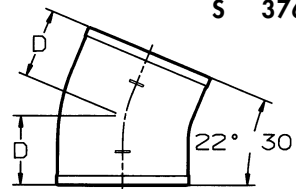

**SIXTEENTH BEND**

Ship Code	UPC No. 670610	Size	D	Wt.
S	007487	1 <sup>1</sup> / <sub>2</sub>	2 <sup>1</sup> / <sub>8</sub>	1.0
<b>S</b>	<b>007494</b>	<b>2</b>	<b>2<sup>1</sup>/<sub>8</sub></b>	<b>1.3</b>
S	007500	3	2 <sup>1</sup> / <sub>4</sub>	2.4
<b>S</b>	<b>007517</b>	<b>4</b>	<b>2<sup>5</sup>/<sub>16</sub></b>	<b>3.8</b>
S	007524	5	2 <sup>7</sup> / <sub>8</sub>	5.4
<b>S</b>	<b>007531</b>	<b>6</b>	<b>3</b>	<b>7.3</b>
S	007548	8	3 <sup>3</sup> / <sub>4</sub>	12.0