

SAMPLE SPECIFICATION

Flanged Fittings, 2" through 48" shall be manufactured of Ductile Iron in accordance with all applicable terms and provisions of standards ANSI/AWWA C110/A21.10 (current revisions). Flange surface shall be faced and drilled in accordance with ANSI Class 125 B16.1. All Ductile Iron Flanged Fittings shall be rated for water pressure of 250 PSI. NOTE: Fittings are CEMENT-LINED and seal coated in accordance with ANSI/AWWA C104/A21.4, also available prime coated, bare or epoxy coated. All coated fittings shall be in accordance with NSF-61. Interiors shall be lined and seal coated in accordance with ANSI/AWWA C104/A21.04, "Cement-mortar Lining for Ductile Iron Pipe and Fittings for Water" unless otherwise specified.

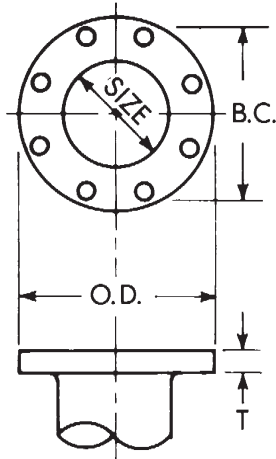

NOTE: No flange joint material furnished.

FLANGE DETAILS

Nominal Pipe Size Inch	Flange O.D.	Dia. of Bolt Circle	Flange Thickness T	Bolt Hole Diameter	Number of Bolts	Bolt Dia. and Lengths
2	6	4.75	.62	.75	4	5/8 x 2 1/4
3	7.5	6	.75	.75	4	5/8 x 2 1/2
4	9	7.5	.94	.75	8	5/8 x 3
6	11	9.5	1.00	.875	8	3/4 x 3 1/2
8	13.5	11.75	1.12	.875	8	3/4 x 3 1/2
10	16	14.25	1.19	1.00	12	7/8 x 4
12	19	17	1.25	1.00	12	7/8 x 4
14	21	18.75	1.38	1.125	12	1 x 4 1/2
16	23.5	21.25	1.44	1.125	16	1 x 4 1/2
18	25	22.75	1.56	1.25	16	1 1/8 x 5
20	27.5	25	1.69	1.25	20	1 1/8 x 5
24	32	29.5	1.88	1.375	20	1 1/4 x 5 1/2
30	38.75	36	2.12	1.375	28	1 1/4 x 6 1/2
36	46	42.75	2.38	1.675	32	1 1/2 x 7
42	53	49.50	2.62	1.625	36	1 1/2 x 7 1/2
48	59.50	56.00	2.75	1.625	44	1 1/2 x 8

NOTE: Drilling templates are in multiples of four, so that fittings may be made to face in any quarter. Bolt holes shall straddle the center line.

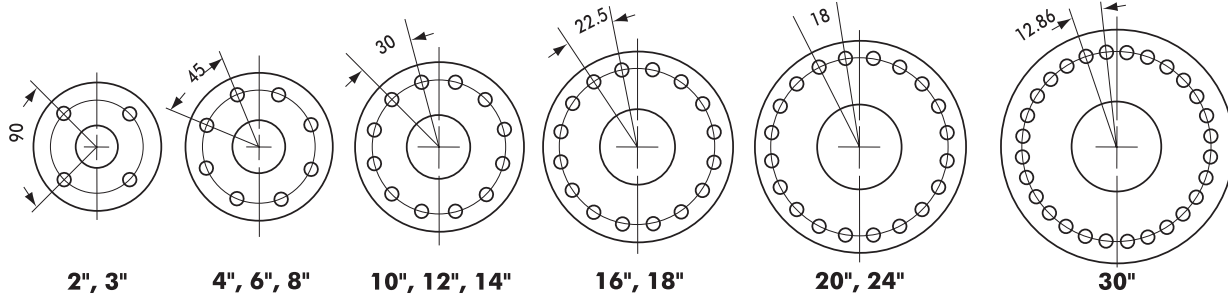

BENDS

Note: Base Bends are on page 33 and 34, reducing and long radius 90° bends are on page 33.



Size	90° Bends (1/4)			45° Bends (1/8)			22 ¹ / ₂ ° Bends (1/16)			11 ¹ / ₄ ° Bends (1/32)		
	Dimensions R	Dimensions A	Weight	Dimensions R	Dimensions A	Weight	Dimensions R	Dimensions A	Weight	Dimensions R	Dimensions A	Weight
2	3.0	4.5	14
3	4	5.5	26	3.62	3	20	7.56	3	22	15.25	3	20
4	4.5	6.5	44	4.81	4	36	10.06	4	35	20.31	4	40
6	6	8	67	7.25	5	57	15.06	5	64	30.5	5	56
8	7	9	115	8.44	5.5	105	17.62	5.5	90	35.5	5.5	90
10	9	11	164	10.88	6.5	131	22.62	6.5	130	45.69	6.5	130
12	10	12	236	13.25	7.5	196	27.67	7.5	194	55.81	7.5	193
14	11.5	14	330	12.06	7.5	245	25.12	7.5	250	50.75	7.5	245
16	12.5	15	478	13.25	8	315	27.62	8	315	55.81	8	315
18	14	16.5	527	14.5	8.5	422	30.19	8.5	402	60.94	8.5	385
20	15.5	18	878	16.88	9.5	485	35.19	9.5	505	71.06	9.5	505
24	18.5	22	1085	18.12	11	730	37.69	11	528	76.12	11	760
30	21.5	25	1755	27.75	15	1355	57.81	15	1385	116.75	15	1395
36	24.5	28	2135	35.00	18	1755	72.88	18	1790	147.25	18	1805
42	27.5	31	3055	42.25	21	2600	88.00	21	2665	177.69	21	2680
48	30.5	34	4095	49.50	24	3580	103.06	24	3665	208.12	24	3695

TEES, REDUCING TEES, CROSSES

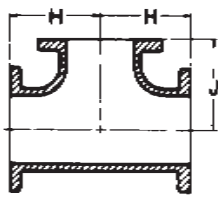

Straight Tees, Reducing on Branch Tees

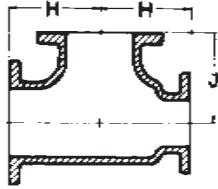

***Reducing on Run**

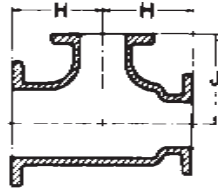

***Reducing on Run and Branch**

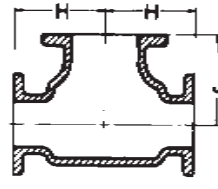

***Bullhead Tees**

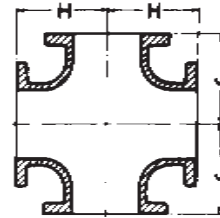

Straight and Reducing Crosses

Straight Tees, Reducing on Branch Tees							*Reducing on Run							*Reducing on Run and Branch							*Bullhead Tees							Straight and Reducing Crosses						
Size			Dimensions		Weights		Size			Dimensions		Weights		Size			Dimensions		Weights		Size			Dimensions		Weights								
Run	Run	Branch	H	J	Tee	Cross	Run	Run	Branch	H	J	Tee	Cross	Run	Run	Branch	H	J	Tee	Cross	Run	Run	Branch	H	J	Tee	Cross							
2	2	2	4.5	4.5	20																													
3	3	2	5.5	5.5	35	...																												
3	3	3	5.5	5.5	42	51																												
4	3	3	6.5	5.5	53	...																												
*4	4	2	6.5	6.5	55	...																												
4	4	3	6.5	6.5	54	76																												
4	4	4	6.5	6.5	60	87																												
*4	4	6	8.0	8.0	88	...																												
*6	4	4	8.0	8.0	96	...																												
*6	4	6	8.0	8.0	100	...																												
*6	6	2	8.0	8.0	85	...																												
6	6	3	8.0	8.0	85	96																												
6	6	4	8.0	8.0	90	112																												
6	6	6	8.0	8.0	98	141																												
6	6	8	9.0	9.0	138	...																												
*8	6	4	9.0	9.0	130	...																												
*8	6	6	9.0	9.0	148	...																												
*8	6	8	9.0	9.0	154	...																												
8	8	3	9.0	9.0	128	140																												
8	8	4	9.0	9.0	155	155																												
8	8	6	9.0	9.0	148	172																												
8	8	8	9.0	9.0	179	195																												
*8	8	10	11.0	11.0	225	...																												
*8	8	12	12.0	12.0	277	...																												
*†10	6	6	13.0	13.0	278	...																												
*†10	6	10	13.0	13.0	308	...																												
*†10	8	6	13.0	13.0	298	...																												
*†10	8	8	13.0	13.0	278	...																												
*†10	8	10	13.0	13.0	325	...																												
10	10	4	11.0	11.0	239	220																												
10	10	6	11.0	11.0	215	242																												
10	10	8	11.0	11.0	254	294																												
10	10	10	11.0	11.0	265	330																												
10	10	12	12.0	12.0	337	...																												
*†12	6	6	14.0	14.0	346	...																												
*†12	6	8	14.0	14.0	362	...																												
*†12	8	6	14.0	14.0	355	...																												

* Not included in AWWA C110
† H and J dimensions are two-inches longer than straight tees.

TEES, REDUCING TEES, CROSSES (Con't)

Run	Size		Dimensions		Tee	Weights Cross
	Run	Branch	H	J		
20	20	6	14.0	17.0	773	...
20	20	8	14.0	17.0	720	...
20	20	10	14.0	17.0	735	...
20	20	12	14.0	17.0	816	820
20	20	14	14.0	17.0	770	...
20	20	16	18.0	18.0	950	1065
20	20	18	18.0	18.0	965	...
20	20	20	18.0	18.0	1005	1175
24	24	6	15.0	19.0	1089	...
24	24	8	15.0	19.0	1060	...
24	24	10	15.0	19.0	1020	...
24	24	12	15.0	19.0	1125	1100
24	24	14	15.0	19.0	1050	1125
24	24	16	15.0	19.0	1070	1160
24	24	18	22.0	22.0	1534	...
24	24	20	22.0	22.0	1510	1695
24	24	24	22.0	22.0	1685	1850
*30	30	6	18.0	23.0	1725	...
30	30	12	18.0	23.0	1801	...
30	30	18	18.0	23.0	1852	...
30	30	24	25.0	25.0	2475	2695
30	30	30	25.0	25.0	2615	2985
36	36	24	20.0	26.0	2255	...
36	36	30	28.0	28.0	3000	...
36	36	36	28.0	28.0	3160	...
42	42	24	23.0	30.0	3245	...
42	42	30	31.0	31.0	4125	...
42	42	36	31.0	31.0	5360	...
42	42	42	31.0	31.0	5580	...
48	48	24	28.0	34.0	4385	...
48	48	30	26.0	34.0	4455	...
48	48	36	34.0	34.0	5555	...
48	48	42	34.0	34.0	7195	...
48	48	48	34.0	34.0	7385	...

* Not included in AWWA C110

FLANGE AND FLARE

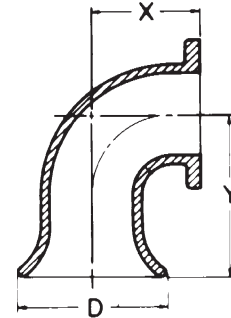

***Flange and Flare 90° Ell**

Size	Dimensions			Weight
	D	X	Y	
3	7.5	5.5	8.5	26
4	9.0	6.5	9.5	39
6	11.0	8.0	12.0	73
8	13.5	9.0	13.0	110
10	16.0	11.0	15.0	171
12	19.0	12.0	16.0	253
14	21.0	14.0	22.0	450
16	23.5	15.0	23.0	545
18	25.0	16.5	24.5	675
20	27.5	18.0	26.0	860
24	32.0	22.0	30.0	1195

* Not included in AWWA C110

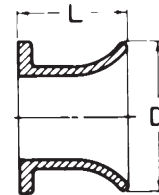

***Flange and Flare Piece**

Size	Dimensions		Weight
	D	L	
3	7.25	8	21
4	9.00	8	30
6	11.00	8	44
8	13.50	10	75
10	16.00	10	113
12	19.00	12	155
14	21.00	16	225
16	23.50	16	330
18	25.00	16	355
20	27.50	18	465
24	32.00	18	598

REDUCERS

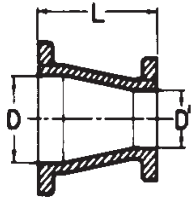

Concentric Reducer

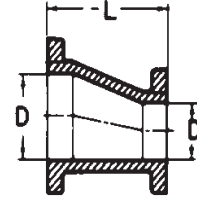

Eccentric Reducer

Concentric Reducer				Eccentric Reducer			
Size		Dimensions	Wts	Size		Dimensions	Wts
D	D ¹	L		D	D ¹	L	
3	2	6	17	18	8	19	265
4	2	7	23	18	10	19	290
4	3	7	29	18	12	19	320
6	2	9	30	18	14	19	350
6	3	9	44	18	16	19	405
6	4	9	46	20	10	20	418
6	5	9	56	20	12	20	465
8	3	11	61	20	14	20	430
8	4	11	63	20	16	20	445
8	5	11	70	20	18	20	470
8	6	11	75	24	12	24	608
10	4	12	98	24	14	24	565
10	6	12	107	24	16	24	610
10	8	12	116	24	18	24	645
12	4	14	119	24	20	24	695
12	6	14	130	30	16	30	945
12	8	14	152	30	18	30	970
12	10	14	178	30	20	30	1144
14	6	16	165	30	24	30	1155
14	8	16	185	42	24	42	1810
14	10	16	205	42	30	42	2060
14	12	16	235	42	36	42	2345
16	6	18	210	48	30	48	2615
16	8	18	230	48	36	48	2940
16	10	18	255	48	42	48	3320
16	12	18	285				
16	14	18	315				

NOTE: Eccentric Reducers not included in AWWA C110

NOTE: Eccentric Reducers Offset
 $1/2 D \text{ minus } 1/2 D^1 = \text{Offset}$
Example:
 6x3 Ecc.Reducer
 $3 - 1\frac{1}{2} = 1\frac{1}{2}" \text{ Offset}$

* WYES

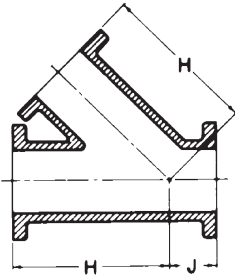

***45° Wye**

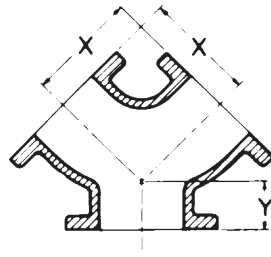

True Wye

Size Run	Branch	Dimensions		Weight
		H	J	
3	3	10	3	49
4	3	12	3	68
4	4	12	3	76
6	4	14.5	3.5	106
6	6	14.5	3.5	131
8	4	17.5	4.5	153
8	6	17.5	4.5	188
8	8	17.5	4.5	201
10	4	20.5	5	232
10	6	20.5	5	288
10	8	20.5	5	333
10	10	20.5	5	300
12	4	24.5	5.5	355
12	6	24.5	5.5	370
12	8	24.5	5.5	395
12	10	24.5	5.5	420
12	12	24.5	5.5	460
14	6	27	6	500
14	8	27	6	525
14	10	27	6	555
14	12	27	6	600
14	14	27	6	640
16	6	30	6.5	655
16	8	30	6.5	680
16	10	30	6.5	715
16	12	30	6.5	755
16	14	30	6.5	800
16	16	30	6.5	850
18	8	32	7	820
18	10	32	7	855
18	12	32	7	1003
18	14	32	7	940
18	16	32	7	990
18	18	32	7	1035
20	10	35	8	1095
20	12	35	8	1130
20	14	35	8	1170
20	16	35	8	1220
20	20	35	8	1345
24	24	40.5	9	2020

Size Stem	Branches	Dimensions		Weight
		X	Y	
4	4	6.5	3.0	49
6	4	8.0	3.5	75
6	6	8.0	3.5	84
8	6	9.0	4.5	134
8	8	9.0	4.5	125

* Not included in AWWA C110

BENDS

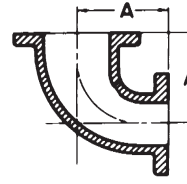

***90° Reducing Bend (1/4)**

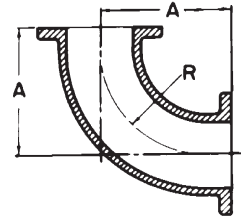

***90° Long Radius Bend (1/4)**

Size	Dimensions		Weight
	A	Weight	
4x3	6.5	35	
6x4	8	65	
8x4	9	88	
8x6	9	96	
10x6	11	126	
10x8	11	151	
12x6	12	172	
12x8	12	191	
12x10	12	218	

Size	Dimensions		Weight
	R	A	
3	6.25	7.75	32
4	7	9	46
6	9.5	11.5	83
8	14	14	140
10	16.5	16.5	252
12	17	19	310
14	19	21.5	475
16	21.5	24	630

* Not included in AWWA C110

* Not included in AWWA C110

BASE BENDS, BASE TEES

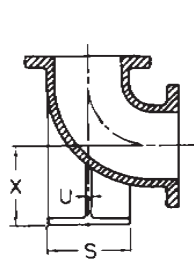

90° Base Bend (1/4)

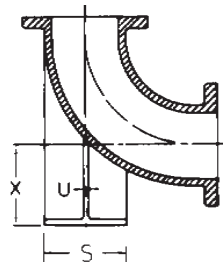

***90° Long Radius Base Bend (1/4)**

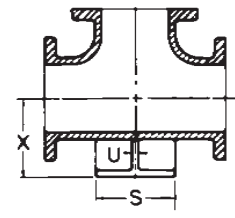

Base Tees

Size	Dimensions			Support Pipe Size	Weight		
	X	S	U		90°	90°LR	Tee
3	4.88	5	.50	1.5	38	41	47
4	5.5	6	.50	2	50	60	76
6	7	7	.62	2.5	83	100	115
8	8.38	9	.88	4	142	180	195
10	9.75	9	.88	4	210	315	315
12	11.25	11	1.00	6	300	427	450
14	12.5	11	1.00	6	400	580	570
16	13.75	11	1.00	6	505	740	710
18	15	13.5	1.12	8	645	...	900
20	16	13.5	1.12	8	805	...	1125
24	18.5	13.5	1.12	8	1215	...	1927
30	23	16	1.15	10	1945

* Not included in AWWA C110

Base Bends are made to order only, not returnable. Bases are furnished faced and drilled.

* Not included in AWWA C110

Tyler/Union

DUCTILE IRON C110 FLANGED FITTINGS

* REDUCING BASE BENDS

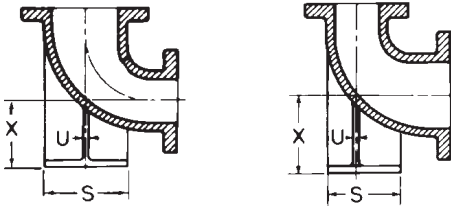

Base Under Large End

Base Under Small End

Size	Dimensions		U	Weight
	X	S		
4x3	5.5	6	.50	45
6x4	7	7	.62	75
8x4	8.38	9	.88	118
8x6	8.38	9	.88	135
10x6	9.75	9	.88	175
10x8	9.75	9	.88	184
12x6	11.25	11	1.00	230
12x8	11.25	11	1.00	255
12x10	11.25	11	1.00	285

* Not included in AWWA C110

NOTE: "X" dimensions are identical on Base-under-large-end and Base-under-small-end. "S" dimensions are determined by the largest fitting opening.

* FLANGE SLUDGE SHOE

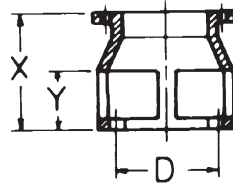

Flange Sludge Shoe

Size	Dimensions			Weight
	D	X	Y	
3	5.75	12	6	28
4	7.00	12	6	35
6	7.87	12	6	45
8	10.12	12	6	69
10	12.25	12	6	88
12	15.25	12	6	120

* Not included in AWWA C110

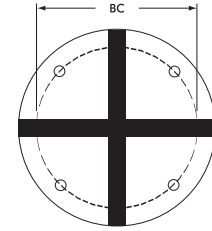

Base Drilling Details

Nom. Diameter Inches	Dimensions - Inches		
	BC	Bolt Hole Diameter	Number of Bolts
3	3.88	5/8	4
4	4.75	3/4	4
6	5.50	3/4	4
8	7.50	3/4	4
10	7.50	3/4	4
12	9.50	7/8	4
14	9.50	7/8	4
16	9.50	7/8	4
18	11.75	7/8	4
20	11.75	7/8	4
24	11.75	7/8	4
30	14.25	1	4
36	17.00	1	4
42	21.25	1-1/8	4
48	22.75	1-1/4	4

FLANGES



Flange for Steel Pipe
Reducing Flange for Steel Pipe



Flange for DI Pipe
Reducing Flange for DI Pipe

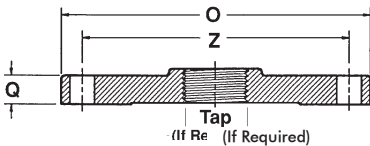

Under 12" Blind Flange
With Optional 2" Taps

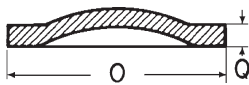

12" and Larger Blind Flange
With Optional 2" Taps

Size	Dimensions				Weight			
	O	Q	Y	Z	Steel	DI	Blind	Blind Tap
2	6	.62	1	4.75	4
2½	7	.69	1.13	5.50	8
3	7.5	.75	1.19	6.00	7	6	8	8
4	9	.94	1.31	7.50	12	11	15	15
6	11	1.00	1.56	9.50	21	14	28	28
8	13.5	1.12	1.75	11.75	28	34	45	45
10	16	1.19	1.94	14.25	49	33	62	62
12	19	1.25	2.19	...	61	52	72	87
14	21	1.38	2.25	72	110	110
16	23.5	1.44	2.5	90	165	165
18	25	1.56	2.69	105	192	190
20	27.5	1.69	2.88	115	249	250
24	32	1.88	3.25	160	375	370
30	38.75	2.12	255	580	580
36	46.00	2.38	790	...
42	53.00	2.62	1175	...
48	59.50	2.75	1585	...

NOTE: All flanges conform to ANSI/AWWA C110/A21.10 Standards.

DI Reducing Flange Threaded For Steel Pipe

Size	Tap x O.D.	Weight
4x3	3x9	16
6x4	4x11	25
8x4	4x13½	44
8x6	6x13½	31
10x6	6x16	50
12x6	6x19	60
10x8	8x16	55
12x10	10x19	72

DI Reducing Flange Threaded For Cast Iron Pipe

Size	Tap x O.D.	Weight
4x3	3x9	16
6x4	4x11	25
8x4	4x13½	40
8x6	6x13½	35
10x8	8x16	50
12x8	8x19	85

Tyler/Union

DUCTILE IRON C110 FLANGED FITTINGS

ADAPTER FLANGES

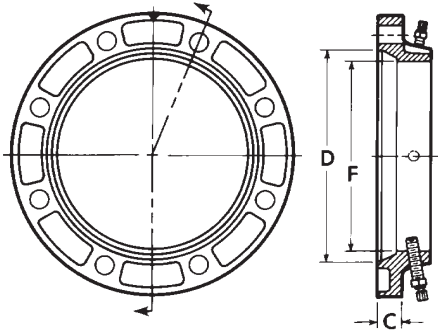

DUCTILE IRON ADAPTER FLANGE

Size	Ductile Iron Pipe OD + .06 or - .06	D + .06 - .04	F + .07 - .03	C	Weight
3	3.96	4.94	4.06	.94	7
4	4.80	6.02	4.90	1.00	10
6	6.90	8.12	7.00	1.06	14
8	9.05	10.27	9.15	1.12	22
10	11.10	12.34	11.20	1.19	30
12	13.20	14.44	13.30	1.25	40

All set screws are $\frac{5}{8}$ " 80 lb. torque head.

Wall Thickness Note: Recommended for Ductile Iron Pipe Class 53 thru Class 56.

See Index for Installation Instructions

Size	Rated Working Pressure	No. of Set Screws	Bolt Circle	No. of Bolt & Nuts	Size of Bolt	Bolt Hole Dia.
3	250	4	6.00	4	$\frac{5}{8} \times 2\frac{1}{2}$	$\frac{3}{4}$
4	250	4	7.50	8	$\frac{5}{8} \times 3$	$\frac{3}{4}$
6	250	8	9.50	8	$\frac{3}{4} \times 3\frac{1}{2}$	$\frac{7}{8}$
8	250	8	11.75	8	$\frac{3}{4} \times 3\frac{1}{2}$	$\frac{7}{8}$
10	250	12	14.25	12	$\frac{7}{8} \times 4$	1
12	150	12	17.00	12	$\frac{7}{8} \times 4$	1

LOCATION OF TAPPED HOLES FOR DRAINS AWWA C110 Flanged Fittings

Fittings can be supplied with taps sized and located to ANSI B16.1 and MSS-SP-45. Specify fitting size, tap location by letter (refer to drawings) and tap size by NPT dimension, on order.

NOTE:
A BOSS IS ALWAYS REQUIRED AT "Y" OR "V" ON STRAIGHT AND REDUCING SIZES OF 90-DEGREE ELBOWS, AND ON TAPERED SIDES OF REDUCERS.

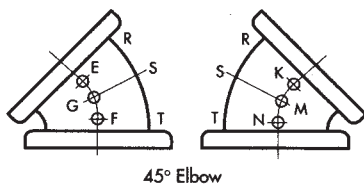
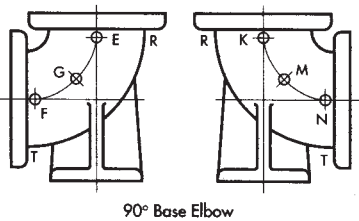
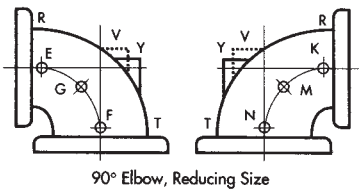
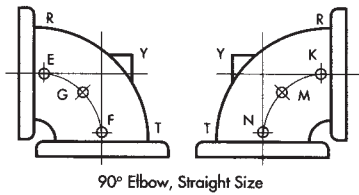

Fitting Size	Maximum Tap Without Boss
3"	1/2"
4" - 6"	3/4"
8"	1-1/4"
10" - 16"	1-1/2"
18" - 30"	2"

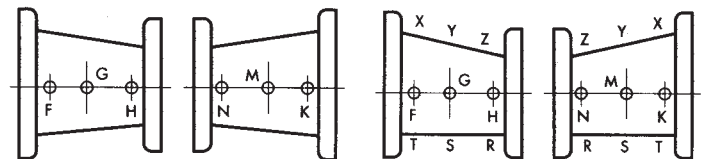
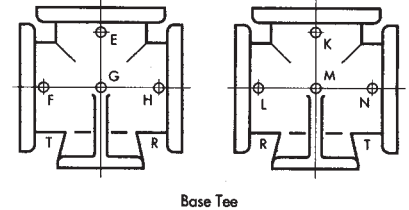
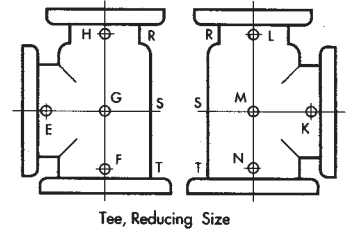
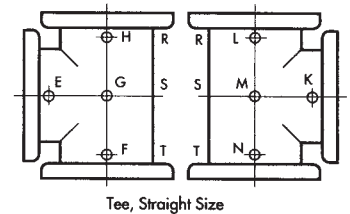
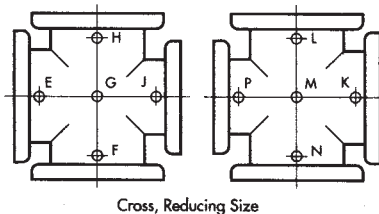
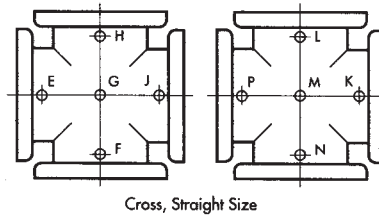

SPECIAL TAP PRICING POLICY

Special taps in fittings apply to C-110 Flanged Fittings only. Flanged Fittings that require a tapping boss will have a one time \$200.00 (net) set up charge per boss per position. Consult your Customer Service Representative for current special tap pricing and more details.